

PRACTICAL MANUAL

ON

FUNDAMENTALS OF AGRONOMY

APA 101 4 (3+1)

(For Undergraduate Agriculture students)

Dr. Gunjan Guleria
Dr. Neelam Bisen
Dr. Rajiv Nandan



2019

College of Agriculture
Department of Entomology
Rani Lakshmi Bai Central Agricultural University,
Jhansi-284 003

Syllabus:

Identification of crops, seeds, fertilizers, pesticides and tillage implements, study of agroclimatic zones of India, Identification of weeds in crops, Methods of herbicide and fertilizer application, Study of yield contributing characters and yield estimation, Seed germination and viability test, Numerical exercises on fertilizer requirement, plant population, herbicides and water requirement, Use of tillage implements-reversible plough, one way plough, harrow, leveler, seed drill, Study of soil moisture measuring devices, Measurement of field capacity, bulk density and infiltration rate, Measurement of irrigation water.

Name of Student

Roll No.

Batch

Session

Semester

Course Name :

Course No. :

Credit

Published: 2019

No. of copies:

Price: Rs.

©RLBCAU, Jhansi

CERTIFICATE

This is to certify that Shri./Km.ID No.....has completed the practical of course.....course No. as per the syllabus of B.Sc. (Hons.) Agriculture/ Horticulture/ Forestry semester in the year.....in the respective lab/field of College.

Date:

Course Teacher

INDEX

S. No.	Practical Exercise	Page No.
1.	Identification of various crops and their characteristics	3-4
2.	To identify the seeds of various crops and their characters	5
3.	To identify different fertilizers	6
4.	Identification of different pesticides	7-8
5.	Identification and uses of different tillage implements	9
6.	To study different agro-climatic zones of India	10-11
7.	Identification of weeds in crops	12
8.	To study different methods of herbicide application and numerical exercises on herbicides	13-14
9.	To study different methods of fertilizer application and numerical exercises on fertilizer doses	15-16
10.	To study about yield attributing characteristics and yield estimation	17-18
11.	To study the seed germination capacity and seed viability of the seed	19-20
12.	Numerical exercises on plant population	21
13.	Numerical exercises on water requirement	22
14.	Measurement of soil moisture through different devices	23
15.	Measurement of field capacity	24
16.	Measurement of bulk density	25
17.	Measurement of infiltration rate	26
18.	Measurement of irrigation water	27-28
	APPENDIX	29-75

Practical No. 1

Objective: Identification of various crops and their characteristics.

Exercise 1: Identify different field crops in crop cafeteria of RLBCAU Jhansi and note down their distinguishing characteristics along with common name, botanical names and family.

S. No.	Common Name	Botanical Name	Family	Characteristics
1.				
2.				
3.				
4.				
5.				
6.				
7.				
8.				
9.				
10.				
11.				
12.				
13.				
14.				
15.				
16.				
17.				
18.				
19.				
20.				
21.				
22.				
23.				
24.				
25.				

Exercise 2: Write different field crops according to their agronomical/economic classification.

S. No.	Common Name	Botanical Name	Family
1.			
2.			
3.			
4.			
5.			
6.			
7.			
8.			
9.			
10.			
11.			
12.			
13.			
14.			
15.			
16.			
17.			
18.			
19.			
20.			
21.			
22.			
23.			
24.			
25.			
26.			
27.			
28.			
29.			
30.			

Practical No. 2

Objective: To identify the seeds of various crops and their characteristics.

Exercise 1: Identify seeds of different field crops shown to you and write the common name, botanical name, family, seed rate, shape and colour of the seed.

S. No.	Common Name	Botanical Name	Family	Seed Rate	Shape	Colour
1.						
2.						
3.						
4.						
5.						
6.						
7.						
8.						
9.						
10.						
11.						
12.						
13.						
14.						
15.						
16.						
17.						
18.						
19.						
20.						
21.						
22.						
23.						
24.						
25.						
26.						

Practical No. 3

Objective: To identify different fertilizers.

Exercise 1: Identify different fertilizer given to you and write their names along with their properties viz., colour, structure and nutrient content (%) of the fertilizer.

S. No.	Name of the fertilizer	Colour	Structure	Nutrient content (%)
1.				
2.				
3.				
4.				
5.				
6.				
7.				
8.				
9.				
10.				
11.				
12.				
13.				
14.				
15.				
16.				
17.				
18.				
19.				
20.				
21.				
22.				
23.				
24.				
25.				

Practical No. 4

Objective: Identification of different pesticides.

Pesticides are chemicals that may be used to kill fungus, bacteria, insects, plant diseases, snails, slugs, or weeds among others. These chemicals can work by ingestion or by touch and death may occur immediately or over a long period of time.

Exercise 1: Identify different pesticides (herbicides, insecticides and fungicides) shown to you and write their common name, trade names and common use.

S. No.	Common name	Trade name	Use

Objective: To study different agro-climatic zones of India.

Exercise 1: Write the names and characteristics of different agro-climatic zones of India by planning commission.

S. No.	Agro-climatic zone	Characteristics
1.	
2.	
3.	
4.	
5.	
6.	

	
7.	
8.	
9.	
10.	
11.	
12.	
13.	

		<hr/> <hr/>
14.		<hr/> <hr/> <hr/> <hr/> <hr/>
15.		<hr/> <hr/> <hr/> <hr/> <hr/>

Exercise 2: Highlight different agro-climatic zones of India using different below mentioned colors against numbers given in map of India.

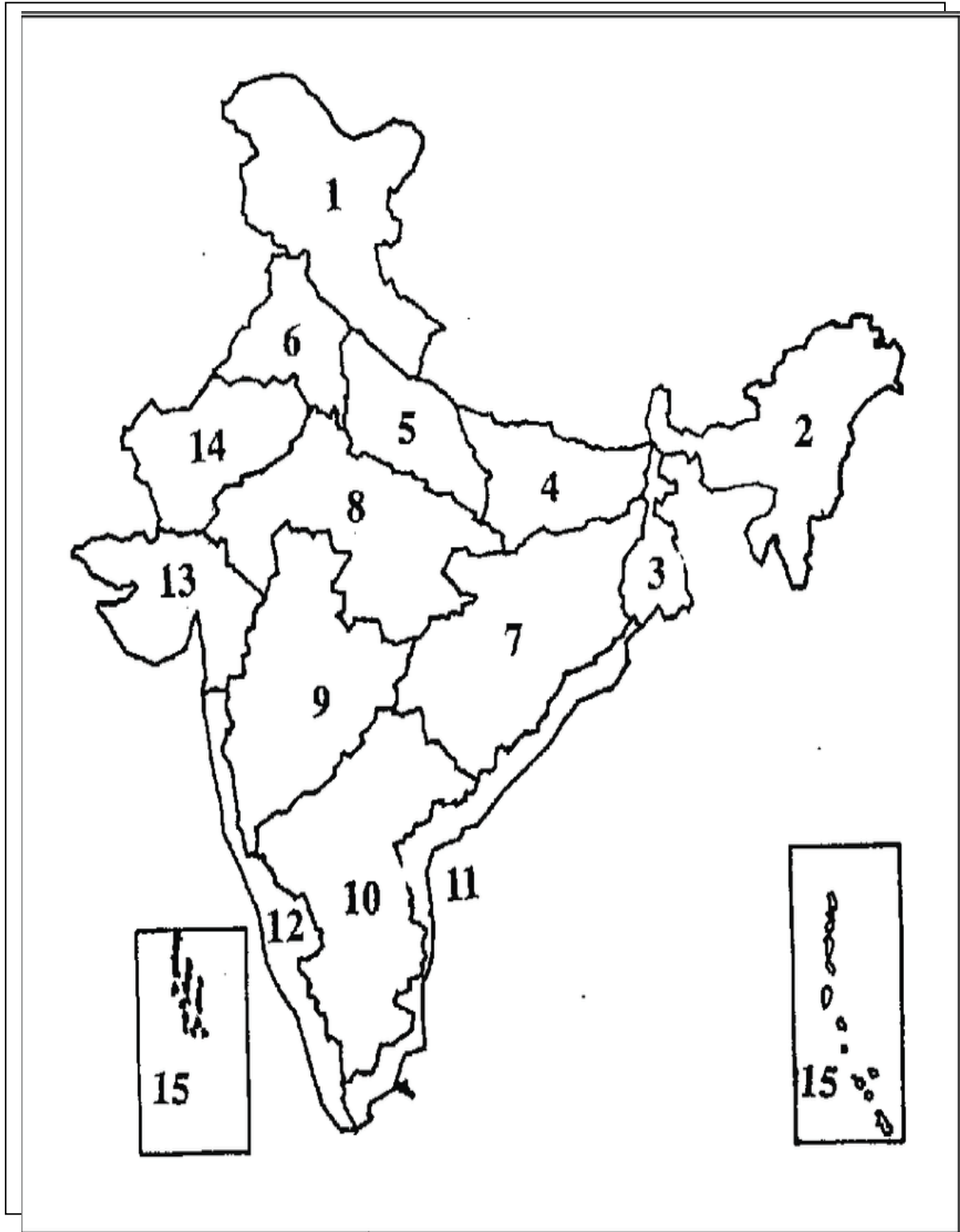

Zone 1	RED	Zone 5	VIOLET	Zone 9	LIGHT GREEN	Zone 13	DARK PINK
Zone 2	ORANGE	Zone 6	LIGHT BLUE	Zone 10	GREY	Zone 14	BLACK
Zone 3	DARK GREEN	Zone 7	BROWN	Zone 11	LIGHT PINK	Zone 15	CYAN
Zone 4	YELLOW	Zone 8	BLUE	Zone 12	CREAM		

Practical No. 7

Objective: Identification of weeds in crops

Exercise 1: Identify the different weeds shown in the field and write their common name, botanical name, group and family

S. No.	Common name (English/ Local)	Scientific name	Group	Family
1.				
2.				
3.				
4.				
5.				
6.				
7.				
8.				
9.				
10.				
11.				
12.				
13.				
14.				
15.				
16.				
17.				
18.				
19.				
20.				
21.				
22.				
23.				
24.				
25.				

Objective: To study different methods of herbicide application and numerical exercises on herbicides.

Exercise 1: Write different methods of herbicide application.

.....
.....
.....
.....
.....
.....
.....
.....
.....
.....
.....
.....
.....
.....
.....
.....
.....
.....
.....
.....
.....
.....
.....
.....
.....
.....
.....
.....
.....
.....
.....
.....
.....
.....
.....
.....
.....
.....
.....
.....

Exercise 2: Calculate the amount of Atrazine (50 % WP) in kg/ha, if rate of application is 1.0 kg ai/ha.

.....

.....

.....

.....

.....

.....

.....

.....

.....

.....

.....

.....

.....

.....

.....

.....

.....

.....

.....

.....

.....

.....

.....

.....

Exercise 3: Suppose Na salt of 2.4-D contains 80% a.i. and if 1½ kg of a.i. per ha is to be sprayed. The quantity of Na salt required will be?

.....

.....

.....

.....

.....

.....

.....

.....

.....

.....

.....

.....

.....

.....

.....

.....

.....

.....

.....

.....

.....

.....

.....

Exercise 2: Calculation of fertilizer requirements of various crops

Problem 1. Calculate the quantity of urea, SSP and MOP required for 1 ha of rice. Recommended dose of NPK is....., respectively.

.....
.....
.....
.....
.....
.....
.....
.....
.....
.....
.....
.....
.....
.....
.....
.....

Problem 2. Calculate the quantity of fertilizers required forarea for sorghum crop. Recommended dose of urea, SSP and MOP is 120:60:60 kg/ha, respectively.

.....
.....
.....
.....
.....
.....
.....
.....
.....
.....
.....
.....
.....
.....

Objective: To study the seed germination capacity and seed viability.

Exercise 1: Write the procedure to determine the germination capacity of the seed.

Apparatus required:

.....
.....
.....

Procedure:

.....
.....
.....
.....
.....
.....
.....
.....
.....
.....
.....
.....
.....
.....
.....
.....
.....
.....
.....
.....
.....
.....
.....
.....
.....
.....
.....
.....
.....
.....
.....
.....
.....
.....
.....
.....
.....
.....
.....
.....
.....
.....
.....
.....
.....
.....

Objective: Numerical exercises on plant population

Exercise 1. A plot has lengthm and widthm. A seed drill having 13 tines is used for sowing of wheat in this plot. Calculate plant population of wheat in the plot if, tines of seed drill are spaced at 20 cm and plant stand in 1 m is 24.

.....

.....

.....

.....

.....

.....

.....

.....

.....

.....

.....

.....

.....

.....

.....

.....

.....

.....

.....

.....

.....

.....

.....

Exercise 2. How many rice seedlings would be required for transplanting inm xm plot area, if crop geometry is 20cm x 20 cm and 2 seedlings per hills are used.

.....

.....

.....

.....

.....

.....

.....

.....

.....

.....

.....

.....

.....

.....

.....

.....

.....

.....

.....

.....

.....

.....

.....

Objective: Numerical exercises on water requirement

Exercise 1: A persian wheel discharges at the rate oflitres per hour and works forhours each day. Estimate the area commanded by the water lift if the average depth of irrigation is 8 cm and irrigation interval is days.

.....

.....

.....

.....

.....

.....

.....

.....

.....

.....

.....

.....

.....

.....

.....

.....

.....

.....

.....

.....

.....

.....

.....

Exercise 2: A tube well with an average discharge oflitres per second irrigates hectare cotton crop in 15 hours. Calculate the average depth of irrigation.

.....

.....

.....

.....

.....

.....

.....

.....

.....

.....

.....

.....

.....

.....

.....

.....

.....

.....

.....

.....

.....

.....

Exercise 3: Wheat crop requires 45 cm of irrigation water during crop season of 125 days. How much area can be irrigated with a flow oflitres per second for 10 hours each day.

.....

.....

Objective: Measurement of field capacity

Exercise 1: Write the materials required and procedure to measure the field capacity.

Materials required:

.....
.....
.....

Procedure:

.....
.....
.....
.....
.....
.....
.....
.....
.....
.....
.....
.....
.....
.....
.....
.....
.....
.....
.....
.....
.....
.....
.....
.....
.....
.....
.....
.....
.....
.....
.....
.....
.....
.....
.....
.....
.....
.....
.....
.....
.....
.....
.....
.....
.....
.....
.....
.....
.....
.....
.....
.....

Example 1: A soil core of 14 cm diameter and 10 cm height weighs 2772g soil (fresh weight) and oven dry weight is 2310g. Find out bulk density.

.....

.....

.....

.....

.....

.....

.....

.....

.....

.....

.....

.....

.....

.....

.....

.....

.....

.....

.....

.....

.....

.....

.....

.....

Example 2: A soil core of 14cm diameter and 10cm height weighs 2602g soil (fresh weight) and oven dry weight is 2000g. The particle density of the soil is 2.5g cm⁻³. Calculate bulk density, and pore space (porosity) of the soil.

.....

.....

.....

.....

.....

.....

.....

.....

.....

.....

.....

.....

.....

.....

.....

.....

.....

.....

.....

.....

.....

.....

.....

Objective: Measurement of irrigation water

Exercise 1: Write different methods for measurement of water.

.....
.....
.....
.....
.....
.....
.....
.....
.....
.....
.....
.....
.....
.....
.....
.....
.....
.....
.....
.....
.....
.....
.....
.....
.....
.....
.....
.....
.....
.....
.....
.....
.....
.....
.....
.....
.....
.....
.....
.....
.....
.....
.....
.....
.....
.....
.....
.....
.....
.....
.....
.....
.....
.....
.....

.....
.....
.....

Exercise 4 Calculate the discharge rate of water of a 90° V-notch with a head of 12 cm.

.....
.....
.....
.....
.....
.....
.....
.....
.....
.....
.....
.....
.....
.....
.....
.....
.....
.....
.....
.....
.....
.....

LIST OF DIFFERENT FIELD CROPS

S. No.	Crop Name	Botanical Name	Family
I Cereals			
1	Paddy	<i>Oryza sativa</i> (L)	Gramineae/poaceae
2	Wheat	<i>Triticum aestivum</i>	Gramineae/poaceae
3	Maize	<i>Zea mays</i> (L)	Gramineae/poaceae
4	Sorghum/Great millet	<i>Sorghum bicolor</i> (L) moench	Gramineae/poaceae
5	Barley	<i>Hordeum vulgare</i>	Gramineae/poaceae
6	Bajra/Pearl millet	<i>Pennisetum glaucum</i>	Gramineae/poaceae
7	Finger millet	<i>Eleusine coracana</i> (L)	Gramineae/poaceae
8	Indian or Foxtail millet	<i>Setaria italic</i>	Gramineae/poaceae
9	Kodo millet	<i>Paspalum scrobiculatum</i>	Gramineae/poaceae
10	Little millet	<i>Panicum millare</i>	Gramineae/poaceae
11	Proso millet	<i>Panicum milliaceum</i>	Gramineae/poaceae
12	Barnyard millet	<i>Echinochloa frumentacea</i>	Gramineae/poaceae
II Pulses			
1	Pigeon pea/Arhar/Tur	<i>Cajanus cajan</i>	Leguminosaeae/Fabaceae
2	Green gram	<i>Vigna radiate</i>	Leguminosaeae/Fabaceae
3	Black gram	<i>Vigna mungo</i>	Leguminosaeae/Fabaceae
4	Kidney bean (Moth bean)	<i>Phaseolus aconitifolius</i>	Leguminosaeae/Fabaceae
5	Cowpea	<i>Vigna sinensis</i>	Leguminosaeae/Fabaceae
6	Horse gram	<i>Macrotylamee uniflorum</i>	Leguminosaeae/Fabaceae
7	Chickpea	<i>Cicer arietinum</i>	Leguminosaeae/Fabaceae
8	Lentil	<i>Lens esculenta</i>	Leguminosaeae/Fabaceae
III Oilseeds			
1	Groundnut	<i>Arachis hypogea</i>	Leguminosaeae/Fabaceae
2	Sesamum	<i>Sesamum indicum</i>	Pedaliaceae
3	Castor	<i>Ricinus communis</i>	Euphorbiaceae
4	Sunflower	<i>Helianthus annus</i>	Compositae
5	Soybean	<i>Glycine max</i>	Leguminosaeae/Fabaceae
6	Rapeseed and mustard	<i>Brassica spp.</i>	Cruciferae
IV Forage crops			
1	Cowpea	<i>Vigna sinensis</i>	Leguminosaeae
2	Stylo	<i>Stylosanthes lamata</i>	Leguminosaeae
3	Siratro	<i>Phaseolus macroptinum</i>	Leguminosaeae
4	Velvet bean	<i>Stizolobium deeringianum</i>	Leguminosaeae
V Fibre crops			
1	Cotton	<i>Gossypium spp.</i>	Malvaceae
2	Jute	<i>Corchorus spp.</i>	Tiliaceae
3	Sunhemp	<i>Crotalaria juncea</i>	Fabaceae
VI Sugar crops			
1	Sugarcane	<i>Sachharum officianarum</i>	Graminae
2	Sugarbeet	<i>Beta vulgaris</i>	Chenopodiaceae
VII Miscellaneous crops			
1	Potato	<i>Solanum tuberosum</i>	Solanaceae
2	Tobacco	<i>Nicotiana spp.</i>	Solanaceae

CHARACTERISTICS OF SOME FIELD CROPS' SEEDS

- Durum wheat:** The kernel has an amber color, and is larger and more tapered than hard red spring wheat. Kernels are long and pointed, usually lopsided and boat-shaped. The germ is protruding, oval and more pointed than in hard red spring wheat. The crease is tight. A brush is not present on most varieties.
- Two-rowed barley:** The shape is broad with a flat back (duck-backed) and blunt ends. The crease is straight and tight, and usually extends out to the end. Plump and short kernels (the result of only two rows on a head) are usually broader and larger than in six-row barley.
- Six-rowed barley:** Kernel shape is longer and narrower, with more of a spike tooth taper at the end than in two-row barley. Two-thirds of the kernel (the outside two rows) is twisted, with a crooked crease. The crease is more open to the end.
- Oat:** The color is white, yellow or tan and the surface of the kernel is practically smooth. The awn, if present, is not bent or markedly twisted. The seed attachment is round and relatively small compared to the large sucker-mouth-shaped

attachment in wild oats. Kernels are long and somewhat pointed at both ends, especially the tip end. The hull (the lemma and palea) is tightly attached to the kernel and accounts for 25 to 35 percent of its weight. The hullless kernel or groat comprises the remainder of the kernel weight.

5. **Corn:** Seed is large, flat and dented in the top. Color ranges from white, yellow, and red to strawberry. Seeds may have a white cap. (Semi-dent, flint, sweet and pop corn will not be included in crop judging contests).
6. **Rye:** Seeds are similar to wheat in shape but are longer and more slender. Color varies but usually is tan, brown or bluish-green. The germ is on the pointed end.
7. **Triticale:** This crop is a cross between wheat and rye. Seeds are similar to rye or durum wheat but are shrunken and wrinkled in appearance. Color is usually a tan or light brown.
8. **Grain sorghum:** The seeds are more or less egg-shaped or oblong and somewhat flat. They are about 5/32 inch long and 1/8 inch wide. The color may be white, yellow, red or brown. White seeds may contain red or brown spots and red seeds may contain red spots, usually due to injury.
9. **Flax:** The seeds are flat and have a smooth, shiny surface. They usually are dark brown or yellow in color. The seeds are somewhat lens shaped, although more rounded at the base than the tip.
10. **Safflower:** Small hulled seed, light gray, tan or cream in color, often showing brown discoloration near point of attachment. Similar in shape to sunflower seed but only half the size.
11. **Soybean:** Seeds vary in color, and vary in shape from nearly round to oval. They are usually smaller than field beans. The color of the hilum (scar or spot on bean where it was attached to pod) varies from black to brown to tan or yellow and is a seed characteristic that is considered in identifying varieties.
12. **Oilseed Sunflower:** Seeds have a broad base but taper to a pointed end. The color is usually black or dark grey. An achene (shell) covers the nut-meat or seed within. They are similar to wild sunflower, only much larger and dark in color.
13. **Field pea:** Seeds are small and may be round, angular or wrinkled. They vary in color but are mostly yellow or green.
14. **Lentil:** Seeds are "lens" shaped (round and rather flat). Color can be tan, brown, olive green, black, or purple-and-black mottled. The seed surface is generally smooth, but on some large seeds may be wrinkled.
15. **Buckwheat:** Seeds consist of a three-sided triangular pericarp (hull) which encloses one true seed. Seed color is tan, dark brown or black. Remnants of the flower sepals often adhere to the outside of the pericarp.
16. **Yellow mustard:** Small round, irregular seed is a dull yellow color. Some shrunken seed will result in non-uniformity of seed size.
17. **Sugarbeet:** Seed is highly irregular in shape. The mature seed is contained within a mature reddish brown to brown outer seed coat. There are both multigerm and non-germ seed types.
18. **Alfalfa:** Seeds vary in shape but often are kidney or mitt-shaped and are greenish-yellow to light brown in color.

IDENTIFICATION OF FERTILIZERS

Fertilizers: Fertilizers are industrially manufactured chemicals containing plant nutrients. Nutrient content is higher in fertilizers than in organic manures. The nutrients are released almost immediately.

Name of the fertilizer	Properties				
	Physical properties			Chemical properties	
	Colour	Solubility	Structure	Reaction	Nutrient content
Urea	White	Highly soluble in water	Granular	Acidic	N=46%
Diammonium phosphate	Brownish	Highly soluble in water	Granular	Alkaline	N=18%; P ₂ O ₅ =46%
SSP	Greyish	Highly soluble in water	Dust	Neutral	P ₂ O ₅ =16-18%; S=10-14%; Ca=18-21%
TSP	Greyish or blackish	Easily soluble in water	Granular	Neutral	P ₂ O ₅ =48%; Ca=15%
MOP	Brick red	Easily soluble in water	Granular	Acidic	K ₂ O=60%
Gypsum	Whitish	Easily soluble in water	Dust	Acidic	S=18%; Ca=33%
Zinc sulphate	Whitish	Easily soluble in water	Granular	Acidic	Zn=36%; S+18%

TRADE NAME, FORMULATION AND ACTIVE INGREDIENT (A.I.) OF COMMON HERBICIDES

S. No.	Common name	Trade name	a.i. content and Formulation
1.	2,4-D (amine)	Zura	58% SL
2.	2,4-D (ester)	Weedmar	Ethyl ester 38% EC
3.	2,4-D (Na salt)	Weedmar	80% WP; 38% EC
5.	Anilofos	Aniloguard	30% EC
6.	Alachlor	Lasso	50% EC
7.	Atrazine	Atrataf	50% SC; 50% WP; 80% WP
8.	Butachlor	Dhanuchlor	50% EC; 50% EW
9.	Bispyribac Sodium	Nominee Gold	10% SC

10.	Carfentrazone	Affinity	50% WG
11.	Chlorimuron-ethyl	Kloben	25% WP
12.	Clodinafop-propargyl	Topik	15% WP
13.	Cyhalofop-butyl	Clincher	10%EC, 10%WP,10%EW
14.	Diclofop-methyl	Iloxan	3% EC
15.	Diuron	Diurex	80% SC; 80% WP
16.	Ethoxysulfuron	Sunrise	15% WDG
17.	Fenoxaprop-P-ethyl	Whipsuper	10% EC; 9.3% EC
18.	Fluchloralin	Basalin	45% EC
19.	Glyphosate	Round up	41% SL; Ammonium salt 71% SG
20.	Imazethapyr	Pursuit	10% SL
21.	Isoproturon	Chemlon	50% WP; 75% WP
22.	Mestsulfuron- methyl	Algrip	20% WP
23.	Metolachlor	Dual	50% EC
24.	Metribuzin	Sencor	70% WP
25.	Oxadiargyl	Topstar	80% WP
26.	Oxadiazon	Ronstar	50% EC
27.	Oxyflourfen	Oxygold	23.5% EC
28.	Paraquat	Gramaxone	24% SL
29.	Pendimethalin	Stompextra	30% EC; 38.7% CS
30.	Pinoxaden	Axial	5.1% EC
31.	Pretilachlor	Rift	50% EC; 37% EW
32.	Propaquizafop	Society	10% EC
33.	Pyrazosulfuron –ethyl	Saathi	10% WP
34.	Pyriithiobac	Hitweed	10% EC
35.	Quizalofop-ethyl	Tergasuper	5% EC
36.	Sulfosulfuron	SF_10	75% WG
37.	Trifluralin	Trifogan	48% EC

INSECTICIDES

ACEPHATE 75% SP

Crop	Common name of the pest	Dosage/ha		
		a.i (gm)	Formulation (gm/ml)	Dilution in Water (Liter)
Cotton	Jassids	292	390	500-1000
	Boll Worms	584	780	500-1000
Safflower	Aphids	584	780	500-1000
Rice	Stem Borer, Leaf Folder, Plant Hoppers, Green Leaf Hopper	500-750	666-1000	300-500
ACETAMIPRID 20% SP				
Cotton	Aphids, Jassids	10	50	500-600
	Whiteflies	20	100	
Rice	BPH	10-20	50-100	500-600

Name of Commodity	Common name of pest	Dose	Exposure Period	Aeration Waiting period
AZADIRACHTIN 0.15% W/W MIN. NEEM SEED KERNEL BASED E.C.				
Cotton	White fly, Bollworm	-	2500 – 5000	500-1000
Rice	Thrips, Stem borer, Brown Plant hopper, Leaf folder	-	1500 – 2500	500
Stored Grain	Red rust Flour beetle, Lesser grain borer, Rice Weevil, Khapra beetle	3.35 gm	7 days	24hours
BACILLUS THURINGIENSIS VAR. GALLERIAE				
Cotton	Bollworm (<i>Helicoverpa armigera</i>)	-	2.0-2.5	1000
Rice	Leaf folder (<i>Cnaphalocrocis medinalis</i>)	-	1.0-3.0	1000
ACETAMIPRID 20% SP				
Stored Whole Cereals and	Rice Weevil (S.o) Lesser Grain Borer, Khapra Beetle	3 tablets (3gm) Per ton OR	Minimum 5 Days (S.o.)	One hour of Partial aeration in case non- polyethylene

Seed Grains Millet, Pulses Dry Fruits, Nuts Spices & Oil Seeds	(T.g), Rust Red Flour Beetle, Saw Toothed Grain Beetle , Caddle Beetle, Drug Store Beetle , Cigarette Beetle , Pulse Beetle	150 gm/100m3 OR 10 gm Pouch Per ton of Commodity OR 150 gm/100 m3.	7 Days (T.g.)	packed commodities allowed by 6-8 hrs of full aeration. For polyethylene packed commodities minimum aeration period is 48hrs. The waiting period for the release of stock is 48hrs in both the cases. Recommendation for bag stock 15 days.
Mild Products : Deoiled Cakes, Rice Bran Flour, Grain Animal & Poultry Food Split Pulses (Dal) & other Processed Food	Long Headed Floor Beetle, Coffee Borer, Dried Fruit Beetle, Flat Grain Beetle, Carpet Beetle	3 tablets/10 (gm) per ton or 225 gm/100m3	5 days	Aeration is waiting Period 7 days to be checked PH3 detector strips.
Empty Godowns & Sheds	Rice Moth, Almond Moth, Mites, Fruit Fly, Granary Weevil, Caddle or Flour worm, Red Flour Beetle, Indian Meal Moth, Larger cabinet Moth, Wheat Kernel Damage in the field Cockroach.	14 tablets/1000 Cu ft. or 150 gm/ 100m3 or 4 pouch 10 gms each/1000 CFT & or 150 gm/100m3	72 hrs	Aeration Period 24 hrs detectors trips or phosphine detect tubes should be used in the premises to signal safety of atmosphere

BEAUVERIA BASSIANA 1.15% W.P.

Cotton	Bollworm	-	2000	400
Rice	Leaf folder	-	2.5kg/hac	750-850

BIFENTHRIN 10% EC

Cotton	Bollworm White Fly	80	800	500
Rice	Stem borer, leaf folder & Green leaf hopper	50	500	500
Sugarcane	Termites	100	1000	500

CARBOFURAN 3% CG

Use	Method of application	Dosage (a.i.)		Dilution in Water
Barley	Aphid	1000		33300
	Jassids	1250		41600
	Cyst nematode	1000		33300
Bajra	Shoot fly	1500		50000
Sorghum	Shoot fly,	1000		33300
	Stem borer	250		8300

FUNGICIDES

Crop	Common name of the disease	Dosage ha ⁻¹		
		a.i (gm)	Formulation (g ml ⁻¹)	Dilution in Water (Liter)
AUREOFUNGIN 46.15% W.V. SP				
Paddy	Blast, Brown leaf spot	-, -	0.005%, 0.005%	500, 500
AZOXYSTROBIN 23% SC				
Potato	Early blight	-	0.005%	750
BENOMYL 50 % WP				
Wheat	Loose smut	1 gm	2 gm	1 kg of seed
Groundnut	Tikka leaf spot	112.5 g	225 g	750
Tobacco	Frog eye spot	112.5 g	225 g	750
CAPTAN 50% WG				
Potato	Early blight & Late blight	750 g	1500 g	500
CAPTAN 75% WP				
Potato	Early blight	1250 g	1667 g	1000
	Late blight	1250 g	1667 g	1000
Paddy	Leaf spot	750 g	1000 g	750
CARBENDAZIM 50% WP				
Paddy	Blast	125-250 g	250-500 g	750 L
	Sheath blight	1g kg ⁻¹	2 g kg ⁻¹ seed	(1 ltr 10 kg seed ⁻¹)

		seed		(seed treatment)
	Aerial phase	125-250 g	250-500 g	750
Wheat	Loose smut	1g kg ⁻¹ seed	2 g kg ⁻¹ seed	(1 ltr. 10 kg ⁻¹ seed) (seed treatment Before sowing)
Barley	Loose smut	1 gm kg ⁻¹	2 g kg ⁻¹	(1 ltr. 10 kg ⁻¹ seed) (seed treatment before sowing)
CARBOXIN 75% WP				
Wheat	Flag smut	1.5 -1.875 g kg ⁻¹ seed	2 -2.5 g kg ⁻¹ Seed	N/A
	Loose smut	1.5 - 1.875 g kg ⁻¹ seed	2 -2.5 g kg ⁻¹ seed	N/A
	Bunt	1.5 - 1.875 g kg ⁻¹ seed	2 -2.5 g kg seed	N/A
Barley	Loose smut	1.5 - 1.875 g kg ⁻¹ seed	2 -2.5 g kg ⁻¹ seed	N/A
	Covered smut	1.5 - 1.875 g kg ⁻¹ seed	2 -2.5 g kg ⁻¹ seed	N/A
Cotton	Angular leaf spot	1.5 - 1.875 g kg ⁻¹ seed	2 -2.5 g kg ⁻¹ seed	N/A/
COPPER OXY CHLORIDE 50% WP				
Potato	Early Blight	1.25	2.5	750-1000
	Late Blight	1.25	2.5	750-1000
Paddy	Brown Leaf Spot	1.25	2.5	750-1000
Tobacco	Downy Mildew	1.25	2.5	750-1000
	Black Sank	1.25	2.5	750-1000
	Frog eye leaf	1.25	2.5	750-1000
COPPER HYDROXIDE 77% WP				
Groundnut	Tikka leaf spot	937 g	1875 g	500
Rice	False smut	1000 g	2000 g	750
DIFENOCONAZOLE 3% WS				
Wheat	Loose smut	6g 100 kg seed ⁻¹	200 g 100 kg seed ⁻¹	10-20 ml water kg ⁻¹ seed

TILLAGE IMPLEMENTS

Any device used to carry on some work is called as implement. Implements are operated by animal power or by machinery. Implements are classified into primary, secondary and intercultural, depending on the purpose for which it is being used.

Primary Tillage Implements: Primary tillage is the deepest operations/performed during the period between two crops. The following are the implements used for primary tillage.

1. Country/wooden/Desi plough - The indigenous plough consists of a wooden body to which a handle and a shaft pole are attached. The body is made of a bent piece of hard wood with two arms making an angle of about 135°. It is given a wedge shape with an isosceles triangular section. A small piece of flat iron (shares) serves as the piercing point of the plough and is fixed over the plough body with clamps. The shaft pole is secured with the yoke during working. The working of plough results in the opening of 'V' shaped furrow. The width of furrow depends on the size of the plough bottom.

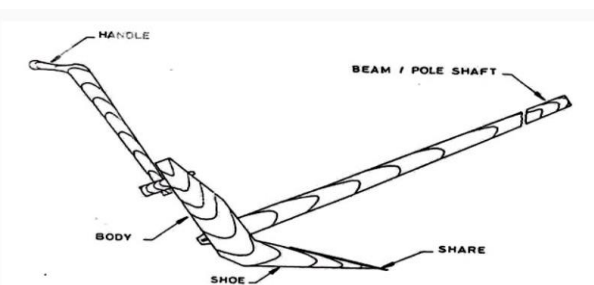

2. Improved iron plough - The bullock drawn improved iron plough is made of mild steel except the pole shaft and hence it has longer life. As and when the share wears off, it can be pushed forward. Pole shaft angle and height of the handle can be adjusted according to field requirements. The plough is provided with a mould board as

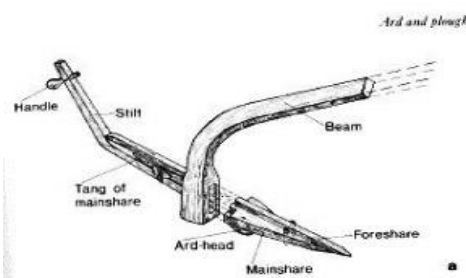
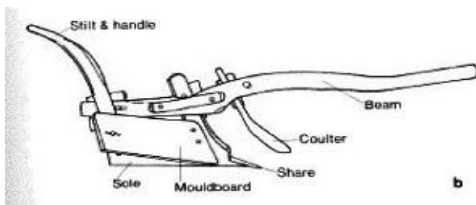

optional attachment for soil inversion. This plough is suitable for dry ploughing in all types of soil with a pair of bullocks.

3. Mould board plough - It is a modern tillage implement used to plough deeply and pulverize the soil. It is more durable, easy to pull and can be adjusted properly. The main parts of the mould board plough are the frog or body, handle, beam, share, mould board, wheel and coulters. This type of plough leaves no unploughed land as the furrow slices are cut clean and inverted to one side resulting in better pulverization. The animal drawn mould board plough is small, ploughs to a depth of 15 cm.

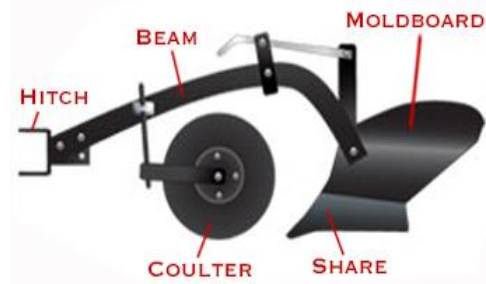

4. Disc plough - In the disc plough, the share, the mould board and coulters of the mould board plough are replaced by an inclined concave steel disc 60-90 cm diameter, set at an angle to the direction of travel. Each disc revolves on an axle and the angle of the disc to the vertical position and to the furrow wall is adjustable. Lever arrangements are provided to lift the discs clear off the ground and for changing the angle of molding and adjusting the depth of penetration of the discs into the soil.

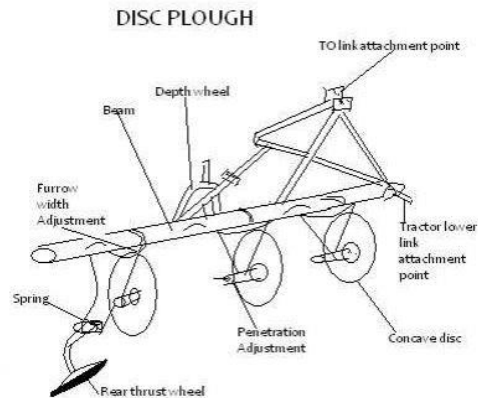

5. Reversible disc plough - It is constructed in such a way that the disc can be reversed and the soil is thrown on one side. The land and furrow wheel adjust themselves properly when the plough is reversed. Reversible disc plough saves time taken up by ordinary disc plough. The furrow slice cut at each trip by the reversible disc plough is laid over the previous furrow thus resulting in a leveled field after ploughing.

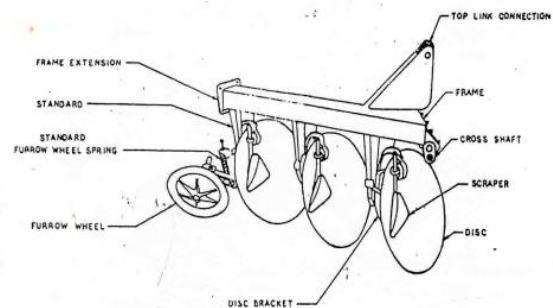

6. Chisel plough or subsoil plough - It is bullock drawn implement used to break hardpan that exists in the soil due to continuous same type of operation. It consists of a curved chisel "C" like tyne with 37 cm radius of curvature and 3 cm thickness. It is rigidly held in a frame, which is provided with a handle and a shaft pole. The operation of this plough is the same as that of an ordinary plough. It makes a simple vertical cut in the sub soil up to a depth of 45 cm and facilitates the downward movement of water and sub soil drainage.

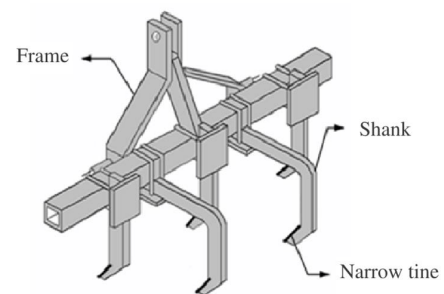

Secondary Tillage Implements

Secondary tillage is the shallow operation performed after the primary tillage. Secondary tillage implements are used for breaking clods and producing a loose, friable, smooth state. These implements are used with the following objectives.

- Breaking the furrow slice and working the soil to get the required tilth
- Destruction of weeds
- Stirring the soil and forming mulch
- Mixing the manures and fertilizers with soil
- Covering the seeds

1. Cultivators - These implements have number of tines for piercing the soil and breaking clods. Tines of 23-30 cm long are fixed to a heavy and sturdy frame, mounted on wheels. These tines penetrate up to a depth of 20 cm in heavy models. Cultivators are used when the soil is ploughed deep with heavy mould board ploughs to break the big clods that are formed.

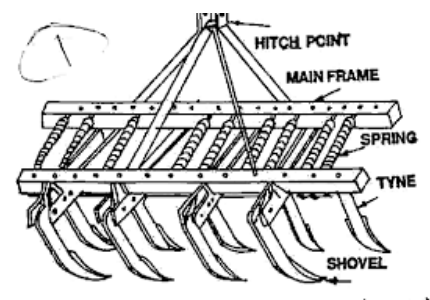

2. **Harrows** - They are smaller implements with many tines like cultivators. Used for breaking smaller clods left unbroken by cultivators and for producing a powdery seedbed. Tines are set closer (5-8 cm) and are smaller in size. They penetrate up to about 10 cm depth. There are different types of harrows in use.

a) Spike tooth harrow

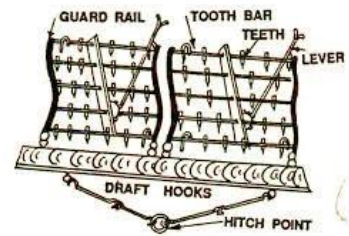

b) Spring tine harrow

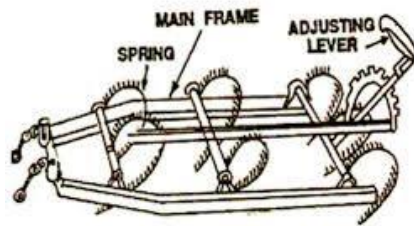

c) Chain harrow

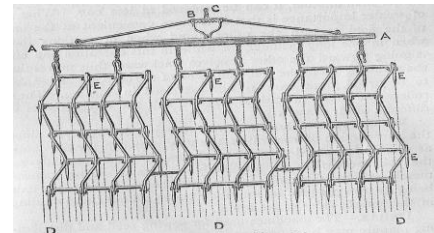

d) Disc harrow

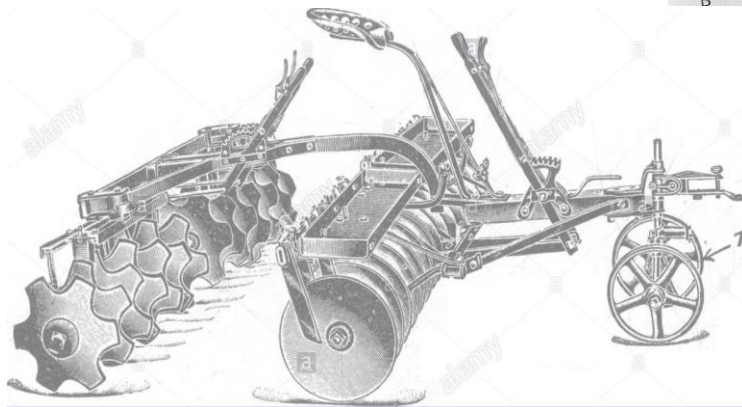

e) Inter-cultivating harrow

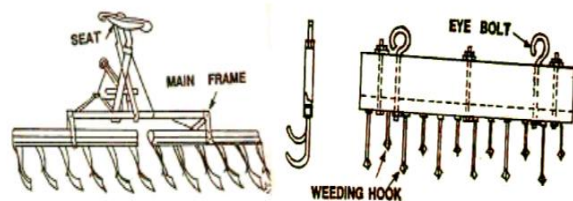

Acme harrow

Patela

f) Blade Harrows

Inter Cultural Implements

(i) **Japanese rotary weeder** - It consists of two small-toothed rollers or drums mounted on a frame provided with handle. Each roller consists of about 5-toothed blades. This implement, while working is pushed and pulled alternatively by the operator in between rows of rice crop. The float provided will guide the implements smoothly while working and prevent the implement sinking into the puddle. The weeder is used to bury the weeds into the mud so as to decompose them add organic matter to the soil, sufficient for working this implement.

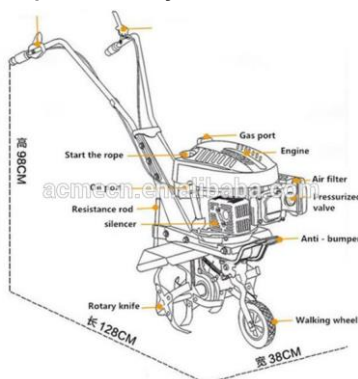
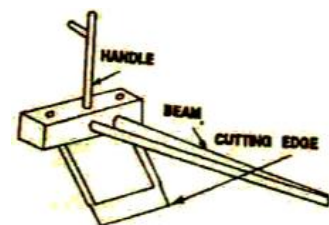

Conoweeder - It is also similar to rotary weeder in which instead of two toothed rollers or drums two toothed cones are mounted on a frame provided with handle. This implement while working is pushed and pulled alternatively by the operation in between rows of rice crop. The float provided will guide the implement smoothly while working and prevent the implement from sinking.

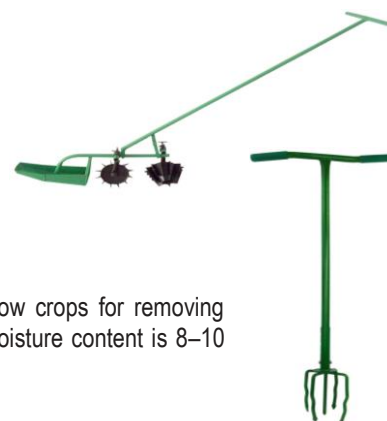

(ii) **Long-handled weeders** - Long handled weeders are used for weeding in row crops for removing shallow rooted weeds. Useful in dry land and garden land crops when the soil moisture content is 8–10 percent. They are manually operated.

AGRO-CLIMATIC REGIONS BY THE PLANNING COMMISSION

An agro-climatic zone is a land unit uniform in respect of climate and length of growing period (LGP) which is climatically suitable for a certain range of crops and cultivars (FAO, 1983). Classification by Planning Commission Planning Commission of India (1989) made an attempt to delineate the country into different agro climatic regions based on homogeneity in rainfall, temperature, topography, cropping and farming systems and water resources. India is divided into 15 agro-climatic regions.

1. **Western Himalayan zone** This zone consists of three distinct sub-zones of Jammu and Kashmir, Himachal Pradesh and Uttar Pradesh hills. The region consists of skeletal soils of cold region, podsolic mountain meadow soils and hilly brown soils. Lands of the region have steep slopes in undulating terrain. Soils are generally silty loams and these are prone to erosion hazards.
2. **Eastern Himalayan zone** Sikkim and Darjeeling hills, Arunachal Pradesh, Meghalaya, Nagaland, Manipur, Tripura, Mizoram, Assam and Jalpaiguri and Coochibihar districts of West Bengal fall under this region, with high rainfall and high forest cover. Shifting cultivation is practiced in nearly one-third of the cultivated area and this has caused denudation and degradation of soils with the resultant heavy runoff, massive soil erosion and floods in lower reaches and basins.
3. **Lower Gangetic Plains zone** This zone consists of West Bengal-lower Gangetic plain region. The soils are mostly alluvial and are prone to floods.
4. **Middle Gangetic Plains zone** This zone consists of 12 districts of eastern Uttar Pradesh and 27 districts of Bihar plains. This zone has a geographical area of 16 million hectares and rainfall is high. About 39% of gross cropped area is irrigated and the cropping intensity is 142%.
5. **Upper Gangetic Plains zone** This zone consists of 32 districts of Uttar Pradesh. Irrigation is through canals and tube wells. A good potential for exploitation of ground water exists.
6. **Trans-Gangetic Plains zone** This zone consists of Punjab, Haryana, Union territories of Delhi and Chandigarh and Sriganganagar district of Rajasthan. The major characteristics of this area are: highest net sown area, highest irrigated area, high cropping intensity and high groundwater utilization.
7. **Eastern Plateau and Hills zone** This zone consists of eastern part of Madhya Pradesh, southern part of West Bengal and most of inland Orissa. The soils are shallow and medium in depth and the topography is undulating with a slope of 1-10%. Irrigation is through tanks and tube wells.
8. **Central Plateau and Hills zone** This zone comprises of 46 districts of Madhya Pradesh, part of Uttar Pradesh and Rajasthan. The topography is highly variable nearly 1/3rd of the land is not available for cultivation. Irrigation and cropping intensity are low. 75% of the area is rainfed grown with low value cereal crops. There is an intensive need for alternate high value crops including horticultural crops.
9. **Western Plateau and Hills zone** This zone comprises the major part of Maharashtra, parts of Madhya Pradesh and one district of Rajasthan. The average rainfall of the zone is 904 mm. The net sown area is 65% and forests occupy 11%. The irrigated area is only 12.4% with canals being the main source.
10. **Southern Plateau and Hills zone** This zone comprises 35 districts of Andhra Pradesh, Karnataka and Tamil Nadu which are typically semi-arid zones. Dryland farming is adopted in 81% of the area and the cropping intensity is 111 percent.
11. **East Coast Plains and Hills zone** This zone comprises of east coast of Tamil Nadu, Andhra Pradesh and Orissa. Soils are mainly alluvial and coastal sands. Irrigation is through canals and tanks.
12. **West Coast Plains and Ghats zone** This zone comprises west coast of Tamil Nadu, Kerala, Karnataka, Maharashtra and Goa with a variety of crop patterns, rainfall and soil types.
13. **Gujarat Plains and Hills zone** This zone consists of 19 districts of Gujarat. This zone is arid with low rainfall in most parts and only 32.5% of the area is irrigated largely through wells and tube wells.
14. **Western Dry zone** This zone comprises nine districts of Rajasthan and is characterized by hot sandy desert, erratic

rainfall, high evaporation, scanty vegetation. The ground water is deep and often brackish. Famine and drought are common features of the region.

15. **Islands zone** This zone covers the island territories of Andaman and Nicobar and Lakshadweep which are typically equatorial with rainfall of 3000 mm spread over eight to nine months. It is largely a forest zone with undulated lands.

LIST OF WEEDS IN DIFFERENT CROPS

RICE (<i>Oryza sativa</i>)			
Grasses	<i>Echinochloa colona</i>	<i>Echinochloa crus-galli</i>	<i>Chloris barbata</i>
	<i>Panicum sp</i>	<i>Cynodon dactylon</i>	<i>Dicanthium anulatum</i>
Sedges	<i>Cyperus difformis</i>	<i>Cyperus iria</i>	<i>Fimbristylis milliacea</i>
Broadleaved	<i>Ammania baccifera</i>	<i>Asteracantha longifolia</i>	<i>Centella asiatica</i>
	<i>Commelina benghalensis</i>	<i>Cyanotis axillaris</i>	<i>Eclipta prostrata</i>
	<i>Marselia quadrifolia</i>	<i>Monochoria vaginalis</i>	<i>Nastrium indicum</i>
	<i>Phyla nodiflora</i>	<i>Phyllanthus niruri</i>	<i>Rotala densiflora</i>
	<i>Ruellia tuberosa</i>	<i>Sonchus oleraceus</i>	<i>Sphaeranthus indicus</i>
WHEAT (<i>Triticum aestivum</i>)			
Grasses	<i>Polypogon monspeliensis</i>	<i>Phalaris minor</i>	<i>Avena ludoviciana</i>
Sedges	<i>Cyperus difformis</i>	<i>Cyperus iria</i>	<i>Fimbristylis milliacea</i>
Broadleaved	<i>Medicago denticulata</i>	<i>Rumex dentatus</i>	<i>Chenopodium album</i>
	<i>Cirsium arvense</i>	<i>Anagallis arvensis</i>	<i>Solanum nigrum</i>
	<i>Argemone mexicana</i>	<i>Lathyrus aphaca</i>	<i>Cirsium arvense</i>
	<i>Oxalis corniculata</i>	<i>Polygonum plebejum</i>	<i>Sonchus olericeus</i>
	<i>Parthenium hysterophorus</i>	<i>Coronopus didymus</i>	<i>Cardemine hirsute</i>
	<i>Vicia sativa</i>	<i>Portulaca oleracea</i>	<i>Fumaria parviflora</i>
	<i>Cynodon dactylon</i>	<i>Calotropis procera</i>	<i>Gnaphalium purpureum</i>
MAIZE (<i>Zea mays</i>)			
Grasses	<i>Cynodon dactylon</i>	<i>Chloris barbata</i>	<i>Dactyloctenium aegyptium</i>
	<i>Pennisetum cenchroides</i>	<i>Brachiaria reptans</i>	
Sedges	<i>Cyperus rotundus</i>		
Broadleaved	<i>Parthenium hysterophorus</i>	<i>Trianthema portulacastrum</i>	<i>Euphorbia prostrata</i>
	<i>Amaranthus viridis</i>	<i>Acalypha indica</i>	<i>Corchorus olitorius</i>
SORGHUM (<i>Sorghum bicolor</i>)			
Grasses	<i>Cynodon dactylon</i>	<i>Dactyloctenium aegyptium</i>	
Sedges	<i>Cyperus sp.</i>	<i>Fimbristylis milliacea</i>	
Broadleaved	<i>Phyllanthus niruri</i>	<i>Solanum nigrum</i>	<i>Celosia argentea</i>
	<i>Leucas aspera</i>	<i>Euphorbia hirta</i>	
RAGI (<i>Eleusine coracana</i>)			
Grasses	<i>Brachiaria reptans</i>	<i>Dactyloctenium aegyptium</i>	<i>Panicum sp</i>
	<i>Rotofolio sp.</i>		
Sedges	<i>Cyperus iria</i>	<i>Fimbristylis milliacea</i>	
Broadleaved	<i>Amaranthus sp.</i>	<i>Cleome gynanadra</i>	<i>Parthenium hysterophorus</i>
	<i>Trianthema portulacastrum</i>		
MINOR MILLETS			
Grasses	<i>Chloris barbata</i>	<i>Cynodon dactylon</i>	<i>Cyperus rotundus</i>
Sedges	<i>Cyperus rotundus</i>		
Broadleaved	<i>Abutilon indicum</i>	<i>Amaranthus spinosus</i>	<i>Celosia argentea</i>
	<i>Gomphrena celosioides</i>	<i>Leucas aspera</i>	<i>Parthenium hysterophorus</i>
	<i>Phyllanthus niruri</i>	<i>Trianthema portulacastrum</i>	<i>Tridax procumbens</i>
	<i>Amaranthus spinosus</i>		
BLACK GRAM (<i>Vigna mungo</i>)			
Grasses	<i>Chloris barbata</i>	<i>Digitaria sanguinalis</i>	<i>Echinochloa sp</i>
Sedges	<i>Cyperus rotundus</i>		
Broadleaved	<i>Amaranthus viridis</i>	<i>Commelina benghalensis</i>	<i>Celosia argentea</i>

	<i>Phyllanthus niruri</i>	<i>Euphorbia hirta</i>	<i>Trianthema portulacastrum</i>
GREEN GRAM (<i>Vigna radiata</i>)			
Grasses	<i>Chloris barbata</i>	<i>Digitaria longiflora</i>	<i>Echinochloa sp</i>
Sedges	<i>Cyperus rotundus</i>		
Broadleaved	<i>Amaranthus viridis</i>	<i>Celosia argentea</i>	<i>Commelina benghalensis</i>
	<i>Euphorbia hirta</i>	<i>Phyllanthus niruri</i>	<i>Trianthema portulacastrum</i>
COW PEA (<i>Vigna unguiculata</i>)			
Grasses	<i>Chloris barbata</i>		
Sedges			
Broadleaved	<i>Amaranthus viridis</i>	<i>Cleome gynandra</i>	<i>Parthenium hysterophorus</i>
	<i>Phyllanthus niruri</i>	<i>Trianthema portulacastrum</i>	
RED GRAM (<i>Cajanus cajan</i> L.)			
Grasses	<i>Chloris barbata</i>	<i>Digitaria sanguinalis</i>	<i>Echinochloa sp</i>
Sedges	<i>Cyperus rotundus</i>		
Broadleaved	<i>Amaranthus viridis</i>	<i>Celosia argentea</i>	<i>Commelina benghalensis</i>
	<i>Euphorbia hirta</i>	<i>Phyllanthus niruri</i>	<i>Trianthema portulacastrum</i>
SOYBEAN (<i>Glycine max</i> L.)			
Grasses	<i>Brachiaria reptans</i>		
Sedges			
Broadleaved	<i>Amaranthus spinosus</i>	<i>Cleome gynandra</i>	<i>Phyllanthus niruri</i>
	<i>Trianthema portulacastrum</i>		
GROUNDNUT (<i>Arachis hypogaea</i>)			
Grasses	<i>Chloris barbata</i>	<i>Cynodon dactylon</i>	
Sedges	<i>Cyperus rotundus</i>		
Broadleaved	<i>Amaranthus viridis</i>	<i>Celosia argentea</i>	<i>Boerhaavia diffusa</i>
	<i>Trichodesma indicum</i>	<i>Portulaca oleracea</i>	
SUNFLOWER (<i>Helianthus annuus</i> L.)			
Grasses	<i>Chloris barbata</i>	<i>Cynodon dactylon</i>	
Sedges	<i>Cyperus rotundus</i>		
Broadleaved	<i>Amaranthus viridis</i>	<i>Celosia argentea</i>	<i>Corchorus olitorius</i>
SESAME (<i>Sesamum indicum</i>)			
Grasses	<i>Chloris barbata</i>		
Sedges	<i>Cyperus rotundus</i>		
Broadleaved	<i>Amaranthus viridis</i>	<i>Celosia argentea</i>	<i>Corchorus olitorius</i>
CASTOR (<i>Ricinus communis</i>)			
Grasses	<i>Chloris barbata</i>	<i>Cynodon dactylon</i>	
Sedges	<i>Cyperus rotundus</i>		
Broadleaved	<i>Amaranthus viridis</i>	<i>Boerhaavia diffusa</i>	<i>Celosia argentea</i>
	<i>Trianthema portulacastrum</i>	<i>Portulaca oleracea</i>	
COTTON (<i>Gossypium sp.</i>)			
Grasses	<i>Chloris barbata</i>	<i>Cynodon dactylon</i>	<i>Dactyloctenium aegypticum</i>
	<i>Echinochloa colonum</i>		
Sedges	<i>Cyperus rotundus</i>		
Broadleaved	<i>Abutilon indicum</i>	<i>Acalypha indica</i>	<i>Achyranthus aspera</i>
	<i>Euphorbia sp</i>	<i>Phyllanthus niruri</i>	<i>Trianthema portulacastrum</i>
	<i>Tridax procumbens</i>		
SUGARCANE (<i>Saccharum officinarum</i>)			
Grasses	<i>Brachiaria reptans</i>		
Sedges	<i>Cyperus rotundus</i>		
Broadleaved	<i>Amaranthus spinosus</i>	<i>Amaranthus viridis</i>	<i>Trianthema portulacastrum</i>
	<i>Cleome gynandra</i>	<i>Coccinia indica</i>	<i>Convolvulus arvensis</i>
	<i>Euphorbia hirta</i>	<i>Ipomea sp</i>	<i>Parthenium hysterophorus</i>
	<i>Phyllanthus niruri</i>		
SWEET SORGHUM (<i>Sorghum bicolor</i>)			
Grasses	<i>Cynodon dactylon</i>	<i>Dactyloctenium aegypticum</i>	
Sedges	<i>Cyperus rotundus</i>		
Broadleaved	<i>Celosia argentea</i>	<i>Euphorbia hirta</i>	<i>Leucas aspera</i>

	<i>Phyllanthus niruri</i>	<i>Solanum nigrum</i>	
FORAGE CROPS			
Grasses	<i>Brachiaria reptans</i>	<i>Chloris barbata</i>	<i>Cyanodon dactylon</i>
	<i>Dactyloctenium aegyptium</i>		
Sedges			
Broadleaved	<i>Boerhaavia diffusa</i>	<i>Euphorbia sp</i>	<i>Ipomea sp</i>
	<i>Parthenium hysterophorus</i>		

Different methods by which these herbicides are applied are tabulated below:

	Soil application		Foliar application
1.	Surface	i.	Blanket spray
2.	Sub surface	ii.	Directed spray
3.	Band	iii.	Protected spray
4.	Fumigation	iv.	Spot treatment
5.	Herbigation		

1. Soil application of herbicides:

(i) Surface application

Soil active herbicides are applied uniformly on the surface of the soil either by spraying or by broadcasting. The applied herbicides are either left undisturbed or incorporated in to the soil. Incorporation is done to prevent the volatilization and photo-decomposition of the herbicides.

e.g. Fluchloralin – Left undisturbed under irrigated condition - Incorporated under rainfed condition

(ii) Subsurface application

It is the application of herbicides in a concentrated band, about 7-10 cm below the soil surface for controlling perennial weeds. For this, special type of nozzles introduced below the soil under the cover of a sweep hood.

e.g. Carbamate herbicides to control *Cyperus rotundus*

Nitralin herbicides to control *Convolvulus arvensis*

(iii) Band application

Application to a restricted band along the crop rows leaving an untreated band in the inter-rows. Later inter-rows are cultivated to remove the weeds. Saving in cost is possible here. For example when a 30 cm wide band of a herbicide applied over a crop row that were spaced 90 cm apart, then two-third cost is saved.

(iv) Fumigation

Application of volatile chemicals in to confined spaces or in to the soil to produce gas that will destroy weed seeds is called fumigation. Herbicides used for fumigation are called as fumigants. These are good for killing perennial weeds and as well for eliminating weed seeds. e.g. Methyl bromide, Metham

(v) Herbigation

It is the application of herbicides with irrigation water both by surface and sprinkler systems. In India farmers apply fluchloralin for chillies and tomato, while in western countries application of EPTC with sprinkler irrigation water is very common in Lucerne.

2. Foliar application

(i) Blanket spray

It is the uniform application of herbicides to standing crops without considering the location of the crop. Only highly selective herbicides are used here e.g. Spraying 2,4-Ethyl Ester to rice three weeks after transplanting.

(ii) Directed spray

It is the application of herbicides on weeds in between rows of crops by directing the spray only on weeds avoiding the crop. This could be possible by use of protective shield or hood. For example, spraying of glyphosate in between rows of tapioca using hood to control *Cyperus rotundus*.

(iii) Protected spray

It is a method of applying non-selective herbicides on weeds by covering the crops which are wide spaced with polyethylene covers etc. This is expensive and laborious. However, farmers are using this technique for spraying glyphosate to control weeds in jasmine, cassava, banana.

(iv) Spot treatment

It is usually done on small areas having serious weed infestation to kill it and to prevent its spread. Rope wick applicator and Herbicide glove are useful here.

Calculating Proper Quantities of Herbicides

Herbicides are usually applied in the form of solution or granules. Solution formulations are applied using sprayers. Granules are generally mixed in sand and applied manually or with the use of applicator. Correct dose of herbicide application is important for effective control of weeds. To calculate the herbicide dose, first account for the dosage (Kg a.i./ha) of chemical required for the crop and active ingredient of herbicide to be used. The quantity of herbicide requirement may be computed by using the formula,

$$\text{Quantity of commercial formulation (kg or l/ha)} = \frac{\text{Dose (kg a.i./ha)}}{\text{Active ingredient(a.i.)}} \times 100$$

Commercially, the herbicides are available either in solid or liquid form. On the label of the containers you will find a.e.= Acid equivalent or a.i. active ingredient for liquids and g/lit solids

Active Ingredient (a.i.):

It is that part of a chemical formulation which is directly responsible for herbicidal effect. Generally expressed as % by weight or by volume. Thus, the commercial herbicide production is made up of two parts i.e. the effective part and the inert part.

Acid equivalents (a.e.):

Some herbicides like phenoxy acetic acid, picloram and chloramben etc. are active organic acid but many of these generally supplied in the form of their salts and esters.

e.g. 2-4 D is available in the form of ester, sodium salt or amine salt. The theoretical yield of the acid in such herbicide formulation is called its acid equivalent. In case of Na salt of 2-4 D, The acid equivalent is 92.5%, which means 2-4 D is 92.5 % in sodium salt.

Example No. 1 Calculate the amount of Atrazine (50 % WP) in kg/ha, if rate of application is 1.0 kg ai/ha.

Solution: Active Ingredient (a.i.) in atrazine = 50 %

Rate of application = 1.0 kg ai/ha.

$$\text{Quantity of atrazine (kg/ha)} = \frac{\text{Dose (kg a. i./ha)}}{\text{Active ingredient(a. i.)\%}} \times 100 = \frac{1}{50} \times 100 = 2.0 \text{ kg/ha}$$

Example No. 2 Suppose Na salt of 2,4-D contains 80% a.i. and if 1 ½ kg of a.i. per ha is to be sprayed. The quantity of Na salt required will be?

Solution: Active Ingredient (a.i.) in 2,4 D = 80 %

Rate of application = 1.5 kg a.i./ha

$$\text{Quantity of 2,4 D (kg/ha)} = \frac{\text{Dose (kg a. i./ha)}}{\text{Active ingredient (a. i.)\%}} \times 100 = \frac{1.5}{80} \times 100 = 1.875 \text{ kg/ha}$$

METHOD OF APPLICATION OF FERTILIZERS

The choice of method and time of fertilizer application depends on the form and amount of fertilizer, convenience of the farmer, the efficiency and safety of fertilizer application.

I. SOLID FORM

1. **Broadcasting** - The manures and fertilizers are scattered uniformly over the field before planting the crop and are incorporated by tilling or cultivating.

2. **Drilling and placement** - Fertilizers are placed in the soil furrows formed at the desired depth. Placement can be done by the following ways.

(i) **Plough sole placement:**

In this method, fertilizers are applied or dropped in the plough sole, which will be covered by the plough during the opening of adjacent furrow.

(ii) **Deep placement** - Fertilizers or manures are placed at the bottom of the top soil at a depth of 10-12 cm, especially in the puddled rice soil.

(iii) **Sub soil application** - Fertilizers are applied in the subsoil especially for tree crops and orchard crops at a depth above 15 cm.

3. **Location or spot application** - Fertilizers are placed in the root zone or the spot near the roots from which roots can absorb easily.

(i) **Contact or drill placement** - Fertilizers or manures are placed at the time of drilling for placing the seeds. Fertilizers or manures will have good contact with the seeds or seedlings.

(ii) **Band placement** - This is the placement of manures or fertilizers or both in bands on the side or both sides of the row at about 5 cm away from the seed or plant in any direction. Such band placement is of three types.

- **Hill placement** - In widely spaced crops, like cotton, castor, cucurbits fertilizers or manures are applied on both sides of plants only but not continuously along the row.

- **Row placement** - In widely spaced crops between rows (Example–Sugarcane, maize, tobacco, potato) manures

- or fertilizers are placed on one or both sides of the row in continuous bands.
- **Circular placement** - Application of manures and fertilizers around the hill or the trunk of fruit tree crops in the active root zone.
 - (iii) **Pocket placement** - Application of fertilizers deep in soil to increase its efficiency especially for the sugarcane pocket placement is done. Fertilizers are put in 2 to 3 pockets opened around every hill by means of a sharp stick.
 - (iv) **Side dressing** - It refers to hill and ring placement of manures or fertilizers. It consists of spreading the fertilizer between the rows or around the plants.
 - (v) **Pellet application** - Nitrogen fertilizers are pelleted like mud ball or urea super granules (USG) and placed deep (10 cm) into the saturated soils (reduced zone) of wet land rice to avoid nitrogen loss from applied fertilizers.

Generally placement of fertilizer is done for three reasons.

1. Efficient use of plant nutrients from plant emergence to maturity.
2. To avoid the fixation of phosphate in acid soils.
3. Convenience to the grower.

II. LIQUID FORM

- (a) **Foliar application:** It refers to spraying of fertilizer solution on the foliage of plants for quick recovery from the deficiency (either N or S).
- (b) **Fertigation:** It is the application of fertilizer dissolved in irrigation water in either open or closed system *i.e.*, lined or unlined open ditches and sprinkler or trickle systems respectively.
- (c) **Starter solutions:** They are solutions of fertilizers prepared in low concentrations which are used for soaking seeds, dipping roots, spraying on seedlings etc., nutrient deficient areas for early establishment and growth.
- (d) **Direct application to the soil:** Liquid fertilizers like anhydrous ammonia are applied directly to the soil with special injecting equipments. Liquid manures such as urine, sewage water and cattle shed washing are directly let into the field.

Calculation of the required amount of fertilizer

$$\text{The required amount of fertilizer (kg)} = \frac{100 \times \text{Dose of nutrient}}{\text{Nutrient content in the applied fertilizer (\%)}}$$

$$\text{The required amount of Nutrient (kg)} = \frac{\text{Nutrient content in the applied fertilizer} \times \text{Dose of fertilizer}}{100}$$

Problem 1. Calculate the quantity of urea, SSP and MOP required for 1 ha of rice. Recommended dose of NPK is 100:50:50 kg/ha, respectively.

Solution:

In urea, %N = 46 kg

In SSP, %P₂O₅ = 16 kg and

In MOP, %K₂O = 60 kg

$$\text{The required amount of urea} = \frac{100 \times 100}{46} = 217.4 \text{ kg}$$

$$\text{The required amount of SSP} = \frac{100 \times 50}{16} = 312.5 \text{ kg}$$

$$\text{The required amount of MOP} = \frac{100 \times 50}{60} = 83.33 \text{ kg}$$

Answer: The required amount of urea, SSP and MOP/ha will be 217.4, 312.5 and 83.33 kg, respectively.

Problem 2. Calculate the quantity of urea, DAP and MOP required for 1 ha of rice. Recommended dose of NPK is 100:50:50 kg/ha, respectively.

Solution:

In DAP, %N = 18 and P₂O₅ = 46

In urea, %N = 46 and

In MOP, %K₂O = 60

As DAP supply both P₂O₅ and N, we have to calculate the amount of DAP first. At first we calculate the amount of P₂O₅ as it presents in higher quantity

$$\text{The required amount of urea} = \frac{100 \times 100}{46} = 217.4 \text{ kg}$$

According to the formula

The required amount of DAP to supply 50 kg P₂O₅ = $\frac{100 \times 50}{46} = 108.69$ kg

The required amount of N present in 108.69kg of DAP = $\frac{18 \times 108.69}{100} = 19.56$ kg

The rest amount of N that will be supplied from urea = 100-19/56 =80.43 kg

Therefore,

The requirement of urea = $\frac{100 \times 80.43}{46} = 174.84$ kg/ha

The requirement of MOP = $\frac{100 \times 50}{60} = 83.33$ kg/ha

Answer: The required quantity of DAP, urea and MOP will be 108.69, 174.84 and 83.33kg, respectively.

(Note: Whenever compound fertilizer is involved, calculate first for the contribution of that fertilizer for the nutrient for the nutrient that is present in higher quality. For example, in the case of DAP, first calculate for P as DAP contains higher quantity of P. Then calculate the quantity of the next highest quantity of nutrient, in this case N, contributed by that of the fertilizer.)

YIELD ATTRIBUTING CHARACTERISTICS AND YIELD ESTIMATION

Yield: In agriculture, crop yield is a measurement of the amount of agricultural production harvested (grains or seeds) from a unit of land expressed as kilograms per hectare. And the characters which are contributing to the yield is known as yield attributing characters.

Each crop having the some specific characteristics which contribute the yield. By this characteristic, the theoretical yield has been calculated. This observation help farmers to choose a suitable crop or variety for cultivation.

In general crop yield, may be estimated by considering two factors: yield per plant and number of plants per unit area.

$$\text{yield (kg/ha)} = \frac{\text{yield per plant (g)}}{1000} \times \text{no of plant in 1 ha area}$$

YIELD ATTRIBUTING CHARACTERS OF MAJOR CROPS

Rice

1. Number of effective tillers/ m² or Number of panicles/ m²
2. Number of spikelet (grain)/ panicles
3. Test weight (g)

Wheat

1. Number of effective tillers/ m² or Number of ear head/ m²
2. Number of grain/ ear head
3. Test weight (g)

Maize

1. Number of cobs/Plant
2. Number grain rows/ cobs
3. Number grain /rows
4. Seed index (g)

Cotton

1. Average no. of sympodial branches/plant
2. Average no. of bolls/branch
3. No. of locules/boll
4. Average no. of seeds/locule
5. Seed to lint ratio
6. Test weight (g)

Oilseed/ Pulse

1. Average no. of matured pods/plant
2. No. of kernels(seed)/pod
3. Test weight (g)

SEED GERMINATION AND VIABILITY TEST

Methods:

Apparatus required:

- a. Working sample
- b. Germination paper
- c. Butter paper
- d. Seed counting board
- e. Germination chamber

1. Petridish method

- Two blotters or filter papers are placed on the bottom of Petridish and they are soaked with water.
- Number of blotters can be increased as per requirement during the need of moisture by seed during germination and size of the seed.
- A convenient number of seeds ranging from 10-20, depending upon their size placed on the surface of water soaked blotters in the Petridish.
- The kind of seed, date and time of seed soaking are to be written on the tea glass cover of Petridish with the help of a glass marking pencil.
- The size of Petridish and number of replicates depend upon the size of seed to be tested.
- Usually the germination percentage is calculated and reported on the basis of the results of germination of about 100 to 200 seeds.
- Generally the two counts of the germinated seeds are carried out for calculation and valid report.
- The Petridish method is more suitable for small seeds like tobacco, tomato, cabbage, cauliflower, mustard, lettuce, brinjal under the blotters or filter papers to increase the water content inside the Petridish.

2. Rolled towel test:

- In this method two wet towels are placed on a smooth table top.
- The appropriate number of seeds are placed on the upper surface of the towels and are covered by two wet towels.
- A fold is made at the bottom of the towel to prevent the seeds from falling out.
- The towel are then rolled from right to left.
- The full information regarding the test i.e., the kind of seeds, lot number, date and time of seed soaking are noted on the roll with the help of a marking pencil.
- The rolls of one type of seed are grouped together and fastened with a rubber band.
- The rolls are then put in a rack.
- These rolled towel are placed in a single layer to avoid the incidence of moulds and save emerging seedlings from charring due to excessive heat evolved during the germination of the seeds.
- The towels should be rolled loosely to allow normal expansion of the seedling during the test period.
- This method is suitable for comparatively large sized seeds like maize, wheat, pea and gram.

3. Germination test through germinator:

There are many types of apparatus used for testing the germination of the seeds.

1. Cabinets of the incubator are thermostatically controlled temperature.
 - In these cabinets seeds maybe placed evenly on moist filter paper in petri dishes or between moist filter papers kept moist on folds where large seeds may be sown in dishes containing sand or fine soil.
 - Adequate water is applied as per needs through wash bottles or sprayers.
2. Box type germinators: It is used basically used for small seed germination.
 - The box type germinators have performed plates made of tins and the seeds are placed over them on special filter papers which are regularly moistened with water.
 - Hot air if needed, is released from below the perforated tin plate through a thermostatically controlled device and required temperature is maintained during the germination period of seeds through regulator and the temperature inside the box mat is known from thermometer fitted therein.
3. Roadewald type germinator consisting of a tray or wet sand on which unglazed porcelain dishes or blocks are bedded.
 - The temperature is controlled thermostatically.
 - The seeds are arranged on porous dishes or blocks which absorb water from the wet sand.
 - The germinated seeds are counted periodically to find out the germination percentage.

Viability:

Seeds capable of germination under suitable conditions is known as viable seed.

Methods for determining seed viability

1. Tetrazolium test
2. Germination test
3. Biochemical test
4. Conductivity test
5. Excised embryo test
6. X-Ray test
7. Free fatty acid test

Tetrazolium Chloride (TZ) test

Tetrazolium test was developed by George Lakon (1940) which is now used for estimation of germination potential in a short time. The test is very useful in processing, handling, storing, marketing, vigour rating of seed lot, supplementary germination test results and diagnosing the cause of seed deterioration.

Objectives:

1. To obtain a quick indication of viability of seed samples.

2. To determine viability of seeds of dormant seeds.

Materials required:

- 2,3,5 Triphenyl Tetrazolium Chloride
- Distill water
- Electronic balance
- Pre-conditioned seed
- Beakers, Petri dishes and other glassware
- Needles
- Forceps
- Magnifying lens
- Oven or incubator

(A) Conditioning and preparing the seeds:

- i. At least 200 randomly pure seeds should be tested in replicate of 100 seeds or less.
- ii. Seeds should be soaked in water overnight at room temperature.
- iii. The water soaked monocot seeds are then cut longitudinally (eg. Wheat, maize) or laterally (eg. Small seeded grasses) to express the embryo. Seed coats of dicot should be removed to facilitate the quick penetration of tetrazolium (eg. gram).

(B) Staining in tetrazole solution:

- i. After preparing the desired number of seeds, they should be soaked in 1% tetrazolium solution (pH 6 - 7) at 30o C for a period of 3 - 4 hrs.
- ii. Solutions with high pH value develops darker stain, while with low pH value develops lighter stain.
- iii. If the acidity of the tetrazolium solution is higher, the colour will not develop even with a viable embryo.

Advantages:

- i. Quick and fairly accurate.
- ii. Can also determine the viability of a dormant seed lot in the short time.
- iii. Seeds are not damaged (in dicot) and can be germinated.

Disadvantages:

- i. Identification between normal and abnormal seedling is difficult.
- ii. Cannot differentiate the dormant and non-dormant seeds.
- iii. Correct evaluation is possible only after prolonged experience.
- iv. Microorganisms harmful for seedling emergence remain undetected.
- v. No sophisticated equipment is desired/ required.

CALCULATIONS ON IRRIGATION REQUIREMENT OF CROPS

Irrigation requirement is the total amount of water applied to the land surface in supplement to the water supply through rainfall and soil profile, to meet the water needs of crops for optimum growth. The water to be applied to the fields can be directly measured with the help of water measuring devices like flumes, notches, orifices and water meters. The various terms in water requirement are:

Net irrigation requirement (NIR)

Net irrigation requirement is the amount of irrigation water just required to bring the soil moisture content in the root zone depth of the crops to field capacity. Thus net irrigation requirement is the difference between the field capacity and the soil moisture content in the root zone before application of the irrigation water. This may be obtained by the relationship given below :

$$d = \sum \frac{n (M_{fci} - M_{bi})}{100} \times A_i \times D_i \quad i=1$$

Where,

- d = net amount of water to be applied during an irrigation, cm
- M_{fci} = Field capacity moisture content (per cent, w/w) in the ith layer of the soil,
- M_{bi} = Moisture content before irrigation in the ith layer of the soil,
- A_i = Bulk density of the soil in ith layer
- D_i = Depth of the ith soil layer, cm, within the root zone and
- n = Number of soil layers in the root zone.

Gross irrigation requirement (GIR)

The total amount of water applied through irrigation is termed as gross irrigation requirement. In other words, it is net irrigation

requirement plus losses in water application and other losses.

Gross irrigation requirement (in field)

$$= \frac{\text{Net irrigation requirement}}{\text{Field efficiency of system}}$$

The gross irrigation requirement at the field head, can be determined as follows:

$$\text{GIR} = \sum_{i=1}^n \frac{d}{E \text{ (application)}}$$

Where,

- GIR = Seasonal gross irrigation requirement at the field head, cm
- d = Net amount of water to be applied at each irrigation, cm
- E application = Water application efficiency and
- n = Number of irrigations in a season

Irrigation frequency

Irrigation frequency refers to the number of days between irrigations during periods without rainfall. It depends on the consumptive use rate of a crop and on the amount of available moisture in the crop root zone and is a function of crop, soil and climate. In designing irrigation systems, the irrigation frequency to be used is the time (in days) between two irrigations in the period of highest consumptive use of the crops grown. The irrigation frequency may be computed as follows:

$$\text{Irrigation frequency (days)} = \frac{\text{FC of soil in effective - Moisture content of the same zone crop root zone at the time of starting irrigation}}{\text{Peak period moisture use rate of crop}}$$

Irrigation period

Irrigation period is the number of days that can be allowed for applying one irrigation to a given design area during the peak consumptive use period of the crop being irrigated. The irrigation system must be so designed that the irrigation period is not greater than the irrigation frequency.

$$\text{Irrigation period} = \frac{\text{Net amount of moisture in the soil between start of irrigation and lower limit of moisture depletion}}{\text{Peak period moisture use rate of crop}}$$

SOIL MOISTURE ESTIMATION

Moisture content of the soil is determined by using various methods, viz., gravimetric method and by using sophisticated instruments like Tensiometers, Resistance blocks and Neutron probe.

1. **Tensiometer method** - Tensiometer is widely used for measuring soil water tension in the field and laboratory. A tensiometer consists of a 7.5 cm long porcelain cup filled with water, which is connected to water filled glass tube, a vacuum gauge and a hollow metallic tube holding all parts together (At the time of installation, system is filled with water.
2. through the opening at the top and closed with a rubber cork).

Principle - When installed in the soil at the required depth, water moves out through the porous cup till the surrounding soil is saturated. It creates a vacuum in the tube, which is measured in the vacuum gauge. When desired tension is reached, the field is irrigated.

Merits

- It is simple and easy to read soil moisture.
- Useful to crops requiring frequent irrigation at low tensions.

Limitations

- Costly (costs about Rs.150/- depending upon its length).
- Sensitivity is only up to 0.85 atmospheric pressure.

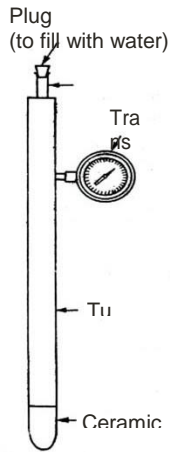

Tensiometer

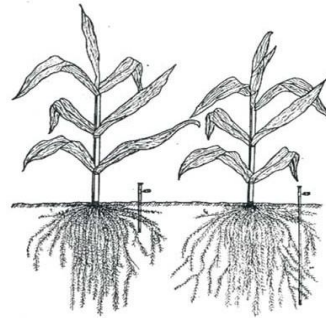

Installation of tensiometer in the field

Materials required - Tube auger, hammer, tensiometer and coloured stakes.

Procedure - Select the spot for installation and bore the soil by driving a tube auger or a hollow pipe with sharp cutting edge which is driven into the soil by hammering it to the desired depth. Insert the tensiometer into the access hole. Compact the soil around the stem of the tensiometer to the original density of soil and make a small soil heap near the tube so that water will not stagnate near the tensiometer. Take the reading in the morning at 8. a.m. Record the reading frequently so that the difference between two consecutive readings is not more than 10 centibars. Plot the readings on a paper against the days.

3. Resistance Block

Gypsum blocks or plaster of paris resistance units are used for measurement of soil moisture *in situ*.

Principle - It works on the principle of conductivity of electricity. When two electrodes are placed parallel to each other in a medium and when electric current is passed, the resistance offered in between two electrodes for the flow of electricity is inversely proportional to the moisture content in the medium. Thus, when the block is wet, resistance is low (conductivity is high). The resistance at field capacity varies from 400 to 600 ohms and at wilting point it varies from 50,000 to 75,000 ohms. The reading on resistance are taken with a portable resistance meter (Bouyoucos meter) operated by dry cells.

Installation of resistance block

Material required - Gypsum or nylon blocks, a post-hole auger, bouyoucos moisture meter.

Procedure - Make a bore (access hole) with a posthole auger to the desired depth. Place the block inside and fill back the bore in small depth by packing the soil with a metal rod to the original density. Ensure and intimate contact of the blocks with the soil. There should not be any root pieces pebbles etc., near the blocks. Normally 3-5 blocks can be placed in one hole at a vertical interval of 30 cm for experimental purpose. Heap the soil to a height of about 3 cm near the surface at the bore space to prevent any water stagnation. Irrigate the field and record the readings, check the resistance readings at the field capacity. In a wide spaced crop, install the block in between two rows of plants. Two or four units are enough for an acre of land for irrigation scheduling.

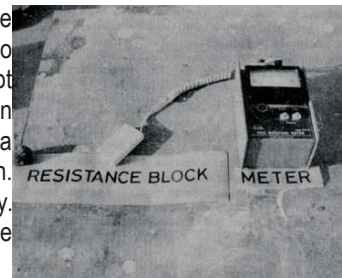

Merits

- Works at low moisture level up to wilting point.
- Suitable for repeated measurement at a point.
- Simple and easy method.

4. Neutron Probe Method

The neutron probe is designed as a field instrument for measuring *in situ* moisture content of the soil. The measurements are made by means of a probe, which is lowered into access tube installed vertically in the soil profile. Soil moisture is determined at specific depths to provide a soil moisture profile.

Principle - The probe contains a sealed Americium-Beryllium radioactive source having fast neutrons. When this source come in contact with soil, it emits fast neutrons into the soil and they

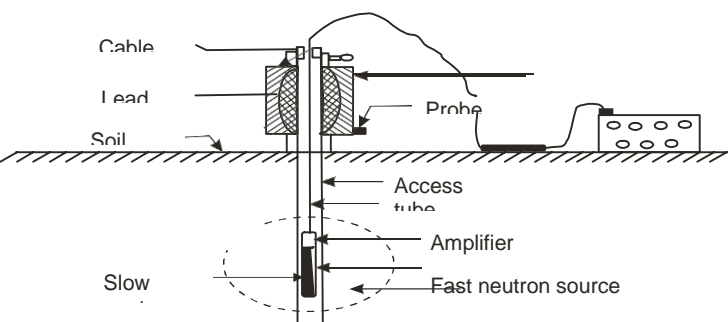

collide with the hydrogen atoms in soil water causing the neutrons to scatter. Thus slow neutrons generated within the soil around is a function of soil moisture content. It is measured by boron trifluoride detector in the probe. This is amplified, displayed digitally as counts per second. The count rate is converted into soil moisture content by calibrations.

Installation of neutron probe

- **Probe Carrier:** Cylindrical, made from tough PVC contains spherical polypropylene moderation shield for the fast neutron in its lower part.
- **Cable:** This connects the rate scaler to the probe, normally 5 m length but permitted to record at the correct count rate to the rate scaler.
- **Rate Scaler:** Cylindrical unit, attached to upper end of the carrier body; shows digitally the density of neutron cloud as counts per second.
- **The Probe:** Consists of a stainless steel cylinder 38 mm diameter and 75 mm long overall. Probe contains Americium-Beryllium source of fast neutrons. Probe can be operated below soil surface to a depth not exceeding 10 m.

MEASUREMENT OF FIELD CAPACITY, BULK DENSITY AND INFILTRATION RATE

FIELD CAPACITY

Field capacity is the moisture content in percentage of a well-drained soil on oven dry basis, few days after complete saturation when downward movement of excess water has practically ceased. Such a stage is reached generally in 48 – 72 hours after saturation. The field capacity is the upper most limit of available moisture range in soil water and plant relationship. The force with which moisture is held at this point varies from 0.1 – 0.33 atmospheric pressure (atm).

The value of field capacity is as under for various textural soil classes.

Textural class of soil	Field capacity	Available soil water (cm m ⁻¹ depth)
Sandy soil	05-10 % by weight	05 – 10
Sandy loam soil	10-18 % by weight	11 – 15
Loam soil	18-25 % by weight	16 – 20
Clay loam soil	24-32 % by weight	17 – 25
Clayey soil	32-40 % by weight	20 – 28

Apparatus required: Straw mulch; Black polythene sheet; Spade; Water; Screw auger; Moisture boxes; Physical balance; Oven; Moisture box container

Procedure:

- Select the representative spot in the field.
- Ensure that water table is not within 2 meters from the layer of which field capacity is to be determined.
- Bund an area of about 2.5 m³ at all the four sides and remove all weeds to avoid transpiration.
- Pond the water till all the desired layer gets sufficiently wet.
- Spread straw mulch of at least 40 cm thickness on the surface of banded plot to prevent evaporation and cover it with gunny bag or polyethylene sheet.
- Put sufficient weight over material to protect it against blowing away due to winds.
- Take soil sample from different layers up to the root zone depth with auger and determine the soil moisture content at every 24 hours intervals till the values of two successive samples are nearly equal.
- The lowest reading in each layer can be taken to represent the value of field capacity of the soil.

Bulk Density:

Bulk density is the ratio of bulk weight of the oven dry soil to its bulk volume. The bulk volume includes volume of air in pore space and soil particles. The value of bulk density is always lower than the real density (particle density mg m⁻³) because air has relatively more volume. It is expressed as mass per unit volume, generally g cc⁻¹. It is denoted as B. D. It is a resultant of relationship between specific gravity and porosity of a physical body.

Specific gravity of soil particles (particle density / true density) varies within narrow limits of 2.60 – 2.70 of g cm⁻³. Bulk density of soil is closely co-related with porosity and in turn, with the infiltration capacity and the degree of aeration. Knowledge of bulk density is of particular importance in the determination of moisture content and other chemical and physical properties of soils.

Objectives:

To determine bulk density of the given soil.

Apparatus required: Core sampler; Moisture boxes; Vernier calipers; Physical balance; Oven

Procedure:

- At field capacity, take the soil of the cores from the desired depths with the help of a core sampler whose volume is pre-determined by measuring height and diameter of the core.

- ii. Transfer the soil of the core in a moisture box and oven dry it.
- iii. Record the oven dry weight.
- iv. Calculate the bulk density by using following formulae

Bulk density (g cc^{-1}) = (Weight of oven dry soil (g)) / (Field volume of soil (cm^3))

Porosity (n) = $[\text{pd} - \text{bd} / \text{pd}] \times 100$

Porosity (n) = $[1 - \text{bd}/\text{pd}] \times 100$

Precautions:

The volume of soil is not always constant as clay colloid swell when wet and shrink when they are dried, Field volume of soil means the volume as in the field condition i.e., volume in natural condition or volume in soil without disturbance.

Following precautions to be taken to avoid the error in measuring bulk density

- i) Bulk density is measured at field condition and preferably at field capacity moisture content.
- ii) When sample is taken by a small core sampler with collar one cannot take the soil sample as usual. Because hammering will cause the compaction of the sub-soil from which soil samples are taken and again handling of the core will be obstructed by the surface soil, as core is not too long. So, for this the whole area of sampling is excavated layer wise, to take subsequent sample from the place close to the hole of previous sample but not from the same point.

INFILTRATION RATE

Determination of infiltration rate of soil by double ring Infiltrometer

The downward entry of water into the soil surface is called as infiltration. It is a surface characteristic and is expressed in cm hr^{-1} . Accumulated infiltration is also called cumulative infiltration, it's the total quantity of water that enters the soil in a given time.

It is an important soil property because it partitions rain in the soil water and runoff. It depends on many factors such as soil texture, moisture content, soil cover and soil management.

Infiltration characteristics of soil are practical significance in irrigation, soil and water conservation and watershed management.

Objective:

To measure the water intake rate of the soil using double ring infiltrameter.

Principles: The main principle is to measure the amount of H_2O entering the soil profile as a function of time. During infiltration appreciable lateral movement of water may also occur. To avoid errors due to the lateral movement of water may also occur. To avoid errors due to the lateral movement of two iron rings (Infiltrometer's) are used. Water level in both rings should be kept nearly equal. The rate of fall of H_2O level in the inner rings is measured.

Apparatus required: Galvanized iron cylinders: 30 (inner cylinder) and 60 (outer cylinder) cm diameter both 30cm in height with circular cap; Hammer; Hook gauge or Scale; Watch with stilling well; Spade; Buckets; Polythene sheet; Stop watch; Jute mat; Water

Double ring Infiltrometer / two ring made from 14 – 16 gauge sheet rolled into a cylinder, ring of 60cm diameter, both of 30cm height. The lower edges of the rings are sharpened to facilitate easy drive of the rings. The top of the rings are provided with steady rims.

Procedure:

Describe the texture, surface condition, structure, compaction, soil moisture content and layering sequence of the soil profile.

- i. Determine the initial soil moisture content.
- ii. Install Infiltrometer rings i.e., outer ring (also called the buffer ring or guard ring) which is used to form buffer pond to avoid divergent flow and then inner ring in a uniform and nearly levelled plot to a depth of 15cm.
- iii. Avoid disturbance of soil within the cylinder.
- iv. Remove the cap.
- v. Pond 10-15cm of water in inner as well as outer Infiltrometer rings.
- vi. Record the recession in water level from the inner ring with hook gauge at suitable intervals i.e., at 1,3,5,10,20,30,40,60,80,100,120 minutes and thereafter on hourly basis till the water intake is constant.
- vii. However, the time intervals of observations can be varied on the basis of objectives of study and soil permeability.
- viii. More water should be added into the rings when water level falls by 4-5cm in order to check drastic water level fluctuations which may affect constant intake rate.
- ix. Use scale or hook gauge to record the water level and note down the time just before and after pre-ponding.
- x. Keep the intervals between these two observations as short as possible to avoid error caused by intake during the refilling period.

- xi. Plot the infiltration rate (cm hr⁻¹) and cumulative (cm) infiltration as function of time.

Precautions to be taken:

- Drive the ring straight down with minimum soil surface disturbance.
- Cover the surface of the soil in the jute mat while pouring water in the rings for the first time to avoid dispersion of surface soil and clogging of pores.
- Do not fill excess water beyond the range of the hook gauge. Prevent evaporation by covering the rings with polythene or by oil film on water surface.
- Try to keep the water level identical in inner as well as outer ring.

MEASUREMENT OF IRRIGATION WATER

Knowledge of the rate and volume of water used is necessary for efficient management of irrigation water used is necessary for the efficient management of irrigation water. Measurement of volume of water used or volumetric flow rate helps in regulating water supply as planned, knowing the quantity of water delivered in various branches of the system over period of time.

Unit of measurement

The quantity of water that flows through a canal or a structure in a period of time is known as flow or discharge and is expressed in m³/s for large discharge and l/s for small discharge.

Units of measurement of water

1. Stored water: Water in reservoirs, ponds, tanks and soils is measured in units of volume i.e. litre, cubic meter, hectare-centimeter and hectare-meter.

- Litre: A volume equal to one cubic decimetre or 1/1000 cubic metre.
- Cubic metre: A volume equal to that of a cube 1 metre long, 1 metre wide and 1 metre deep.
- Hectare-centimeter: A volume covering 1 ha area to a depth of one centimeter.
- Hectare-metre: A volume covering 1 ha area to a depth of one metre.

1 cubic metre = 1000 litres
1 ha cm = 100 m ³ = 100,000 litres
1 ha m = 10,000 m ³ = 10000000 litres

2. Flowing water : Water flowing in rivers, canals, pipelines, field channels is measured by the units of rate of flow i.e. litres per second/hour, cubic metres per second, hectare- Depth of irrigation water is determined with the help of discharge rates. For example – A pump with discharge of 10 lps irrigates one ha area in 20 hrs.

$$\text{The total discharge will be} = 10 \times 60 \times 60 \times 20 = 7,20,000 \text{ litre} = 720 \text{ m}^3$$

$$\text{Depth of irrigation} = \frac{\text{Volume of water (cum)}}{\text{Area irrigated (sqm)}} = \frac{720}{10,000} = 0.072 \text{ m} = 7.2 \text{ cm}$$

Thus the depth of irrigation is 7.2 cm like-wise we need to determine crop area which can be irrigated with a stream. Suppose wheat crop requiring 30 cm irrigation water in 120 days irrigating period. The discharge rate is 10 lps for 20 hours a day.

$$\text{Total discharge (in 120 days)} = 10 \times 60 \times 60 \times 20 \times 120 = 86,40,000 \text{ l} = 86400 \text{ m}^3$$

$$\text{Irrigation requirement per hectare} = \frac{30}{100} \times 10000 = 3000 \text{ m}^3$$

$$\text{Area irrigated} = \frac{\text{Volume of water available (m3)}}{\text{Volume of water required (m3)}} = \frac{86400}{3000} = 28.8 \text{ ha}$$

Thus, an area of 28.8 hectare of wheat crop requiring 30 cm metre can be irrigated with a stream having discharge of 10 lps, flowing 20 hrs/day for 120 days
cm per hour and hectare-metres per day.

- Litre per seconds: A continuous flow amounting to 1 litre passing through a point each second.
- Cubic metre per second: A stream 1 metre wide and are metre deep flowing at a velocity of one metre per second.